

No	a*b	X
1	704x450	1
2	600x450	1
3	542x400	1
4	704x450	1
5	510x58	2
6	400x58	2
7	110x567	1
8	568x450	1

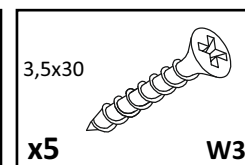

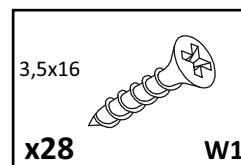
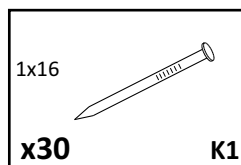
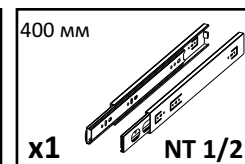
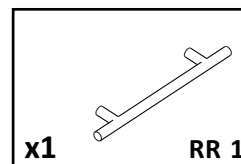
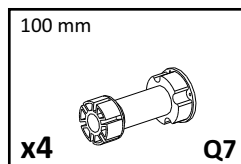
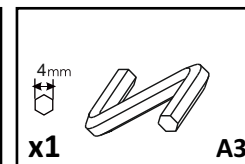
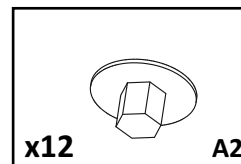
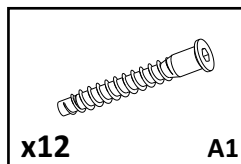
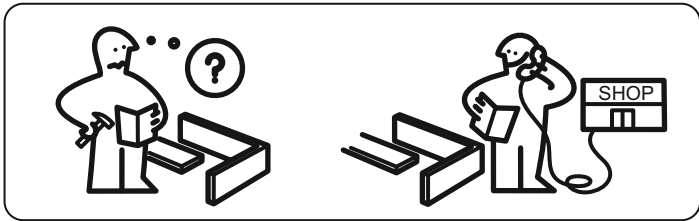
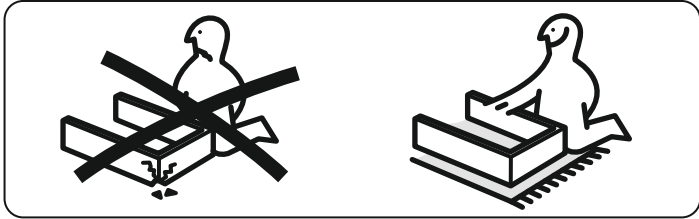
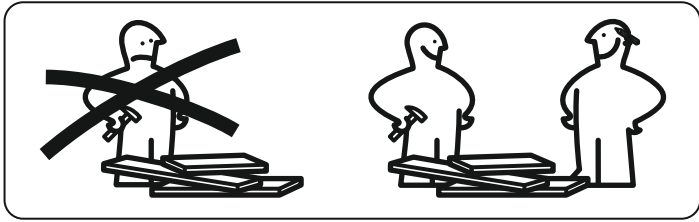
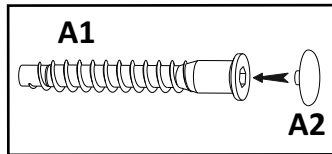
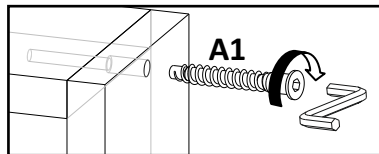
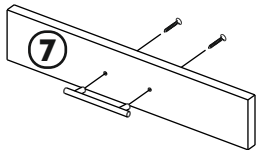
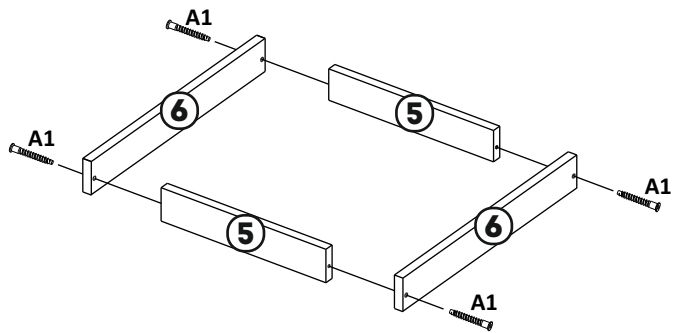
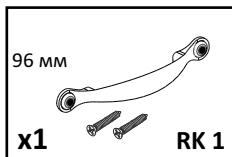
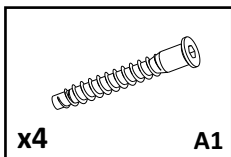
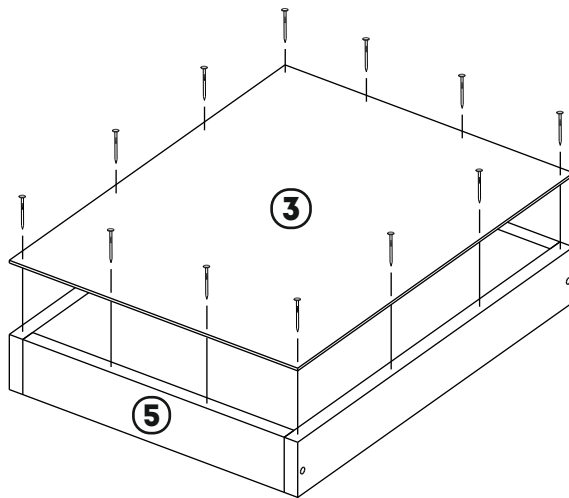
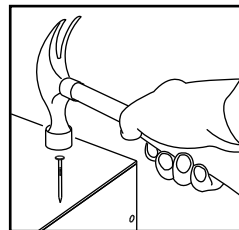
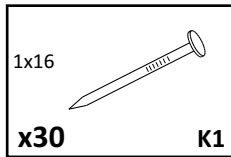

1**2**

3

400 mm

x1

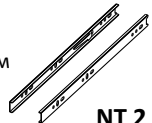

NT 2

3,5x16

x4

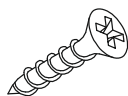

W1

3,5x30

x5

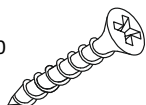

W3

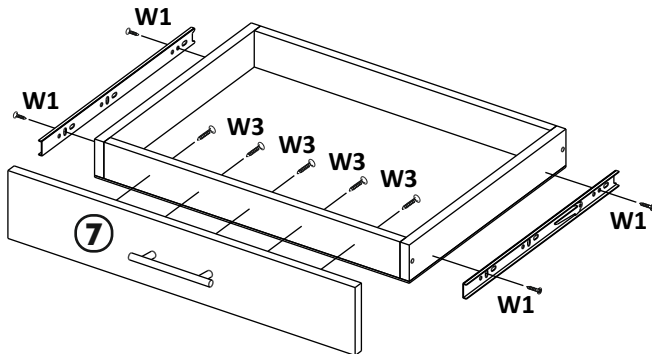

7

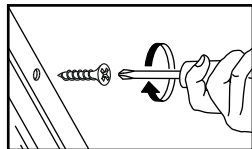

4

3,5x16

x16

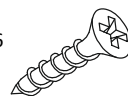

W1

100 mm

x4

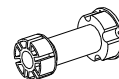

Q7

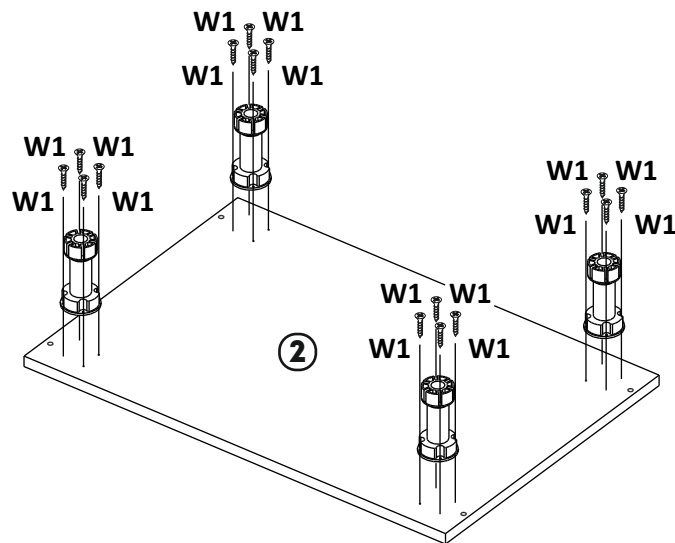

2

5

400 mm

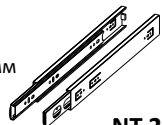
x1**NT 2**

3,5x16

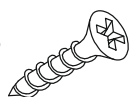
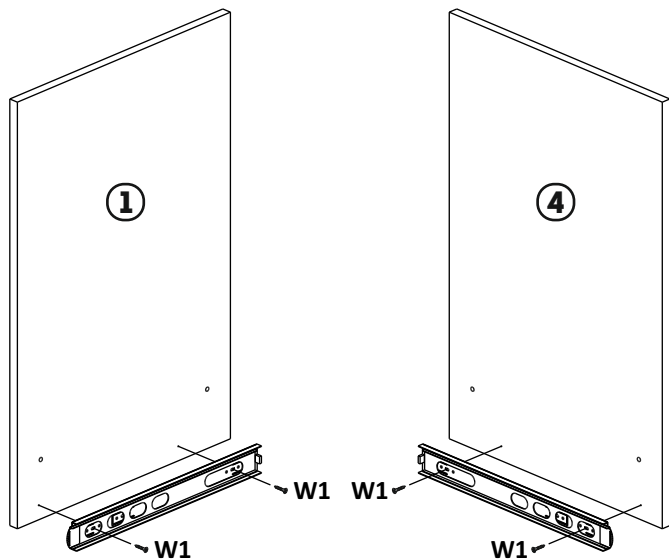
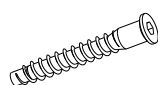
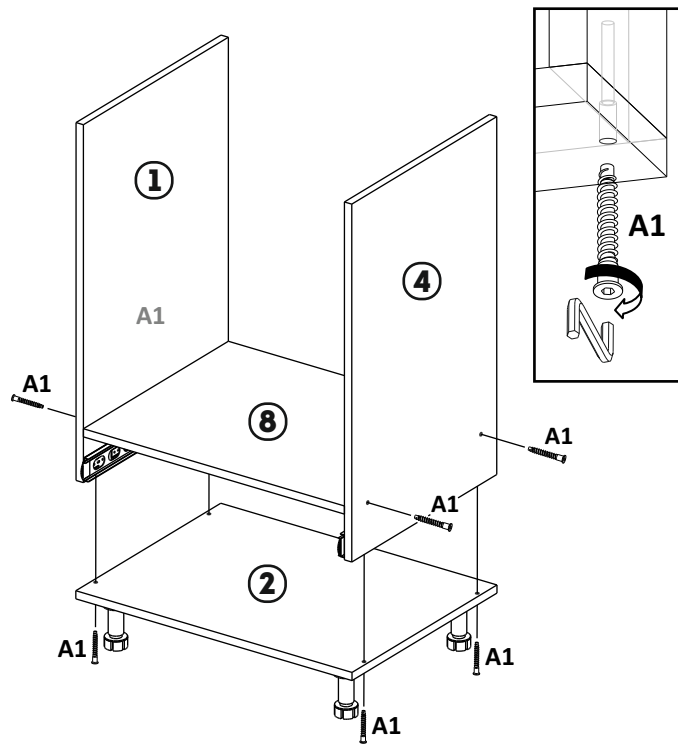
x4**W1****6****x8****A1****x8****A2**

7

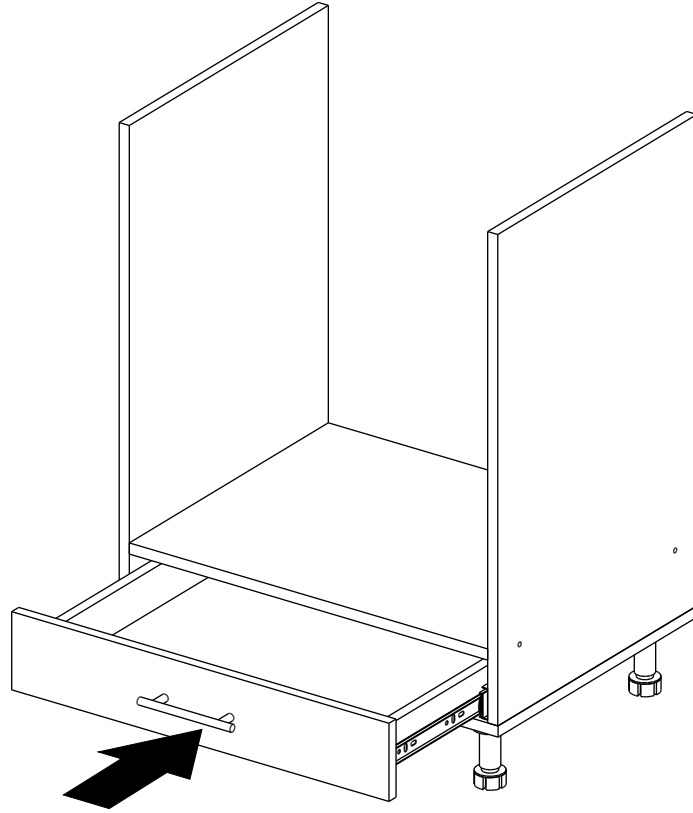

8